



DPX3500

Product Manual

DPX3500

Domino

DPX Fume Extraction Systems. Operator's Reference Guide

This manual, Domino Part No. EPT076596, has been produced for use in the maintenance and operation of the Domino DPX Fume Extraction Systems.

© Domino Printing Sciences plc. 2022.

All rights reserved. No part of this publication may be reproduced, stored on a retrieval system, or transmitted in any form, or by any means, electronic, mechanical, photocopying, recording or otherwise, without the prior permission of Domino UK.

BOFA International Ltd are the manufacturer of this product.

Domino UK and the manufacturer BOFA International Ltd has a policy of continuous product improvement. The Company, therefore, reserves the right to modify the specification contained in this manual without notice.

For sales and service assistance, please contact your local Domino Distributor, or:

Domino UK

Bar Hill

Cambridge CB23 8TU

United Kingdom

Tel: +44 1954 782551

Fax: +44 1954 782874

Amendment Record

Amendment		Date
1	First release	March 2022

Preface

This reference guide, Domino Part No. EPT076596, is for use in the operation and maintenance of DPX fume extraction systems by operators and to reinforce and complement any training program available with the product. It is not designed to replace any such training program.

This reference guide is the official authority for the operation and maintenance of the DPX fume extraction systems. It is the source document for all translated versions. It is the "Original Instructions" for the purposes of the Machinery Directive.

Only engineers trained and certified by Domino should carry out repairs. Genuine Domino parts must always be used to ensure quality and performance.

Users of this equipment are warned that it is essential to read, understand and act according to the information given in this manual. This part of the product manual also specifies a set of symbols which are used elsewhere in the product manual to convey special warnings or requirements. It is, therefore, essential that users are also familiar with these symbols and act accordingly.

Contents

1	01	Overview of the extraction system (front)
	02	Overview of the extraction system (back)
	03	Overview of the display
2	01	Important safety notes
	02	Safety labels
3	01	Unpacking and unit placement
4	01	Fume capture methods
	02	Interfacing
	03	Connecting to power supply & exhaust orientation
5	01	Turning extractor on
	02	Accessing the menu/settings/changing display units
	03	Run controls
	04	Setting the desired airflow
	05	System Status of filters and pump/s
	06	System alarms
6	01	Maintenance
	02	Filter replacement
7	01	USB connectivity
8	01	Maintenance protocol
9	01	DPX3500 specifications

Overview

1 01

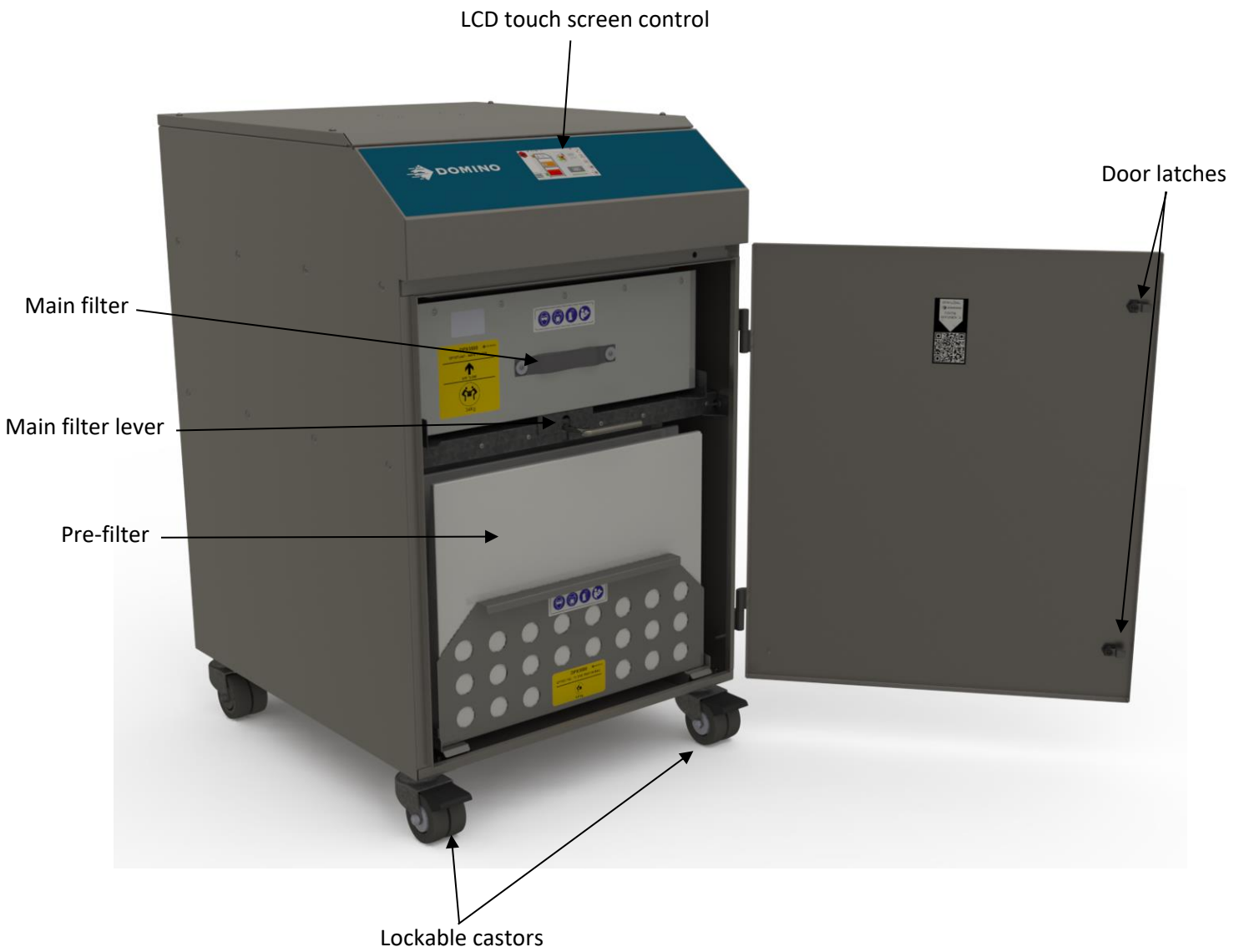

Overview

1 02

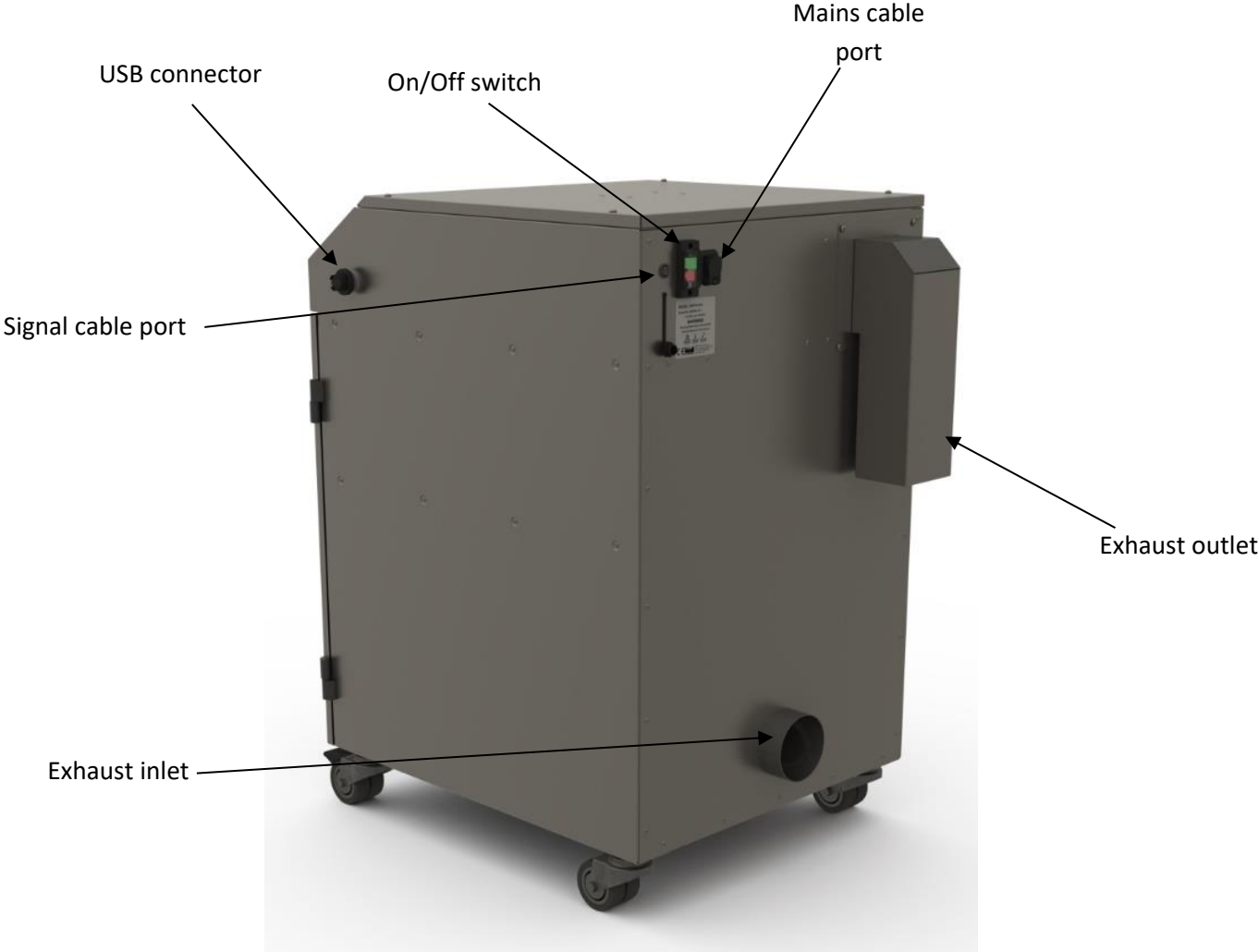

Overview

1 03

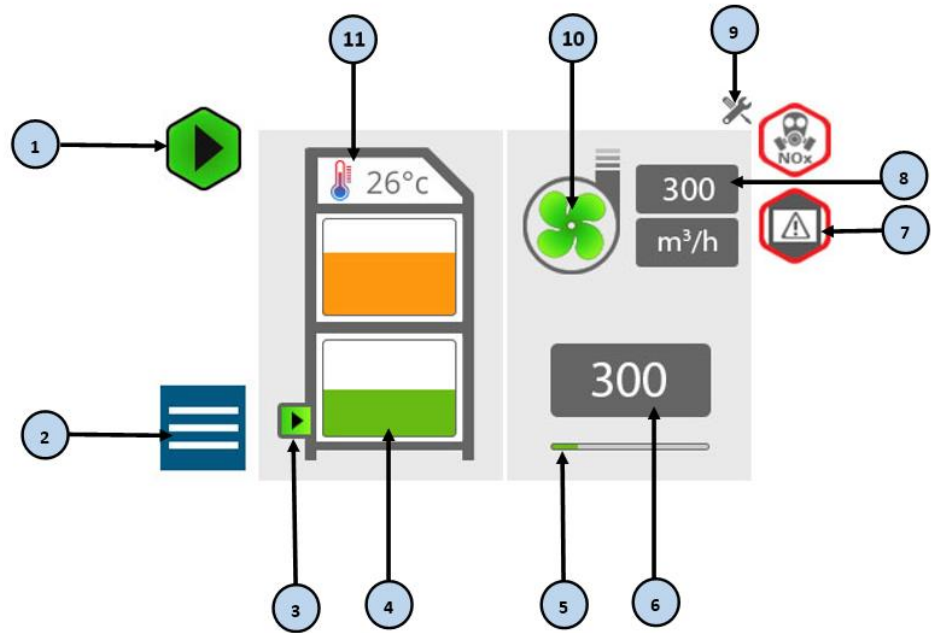

1. Run Control: allows the operator to START/STOP the extraction
2. Access: Navigates to 'Menu' page
3. System Indication: visual indication of inlet condition. As well as Pre and Main filter conditions.
4. Filter Indication: visual indication of filter condition. Pressing will navigate to relevant 'Filter Data' page
5. Airflow level indication: visual indication of flow setpoint relative to maximum setpoint. Pressing will navigate to 'Airflow Setting' page
6. Airflow Setpoint: visual indication of airflow setpoint. Pressing will navigate to 'Airflow Setting' page
7. Alarm Notifications bar: visual indication of alarm states. Will populate with active alarms. Pressing will navigate to 'Alarms' page
8. Actual Flow: visual indication of system flow. Units will be configurable (m³/h or CFM)
9. Service Indication: required system service notification.
10. Blower Status: visual indication of blower status. Pressing will navigate to 'Blower Diagnostics' page
11. Temperature Status: visual indication of internal system temperature. Units will be configurable (degrees °C or °F).

Safety Instructions



Important safety notes

Concerning symbols used on the extraction unit and referred to within this manual.



Danger

Refers to an immediately impending danger. If the danger is not avoided, it could result in death or severe (crippling) injury. Please consult the manual when this symbol is displayed.



Warning

Refers to a possibly dangerous situation. If not avoided, it could result in death or severe injury. Please consult the manual when this symbol is displayed.



Caution

Refers to a possibly harmful situation. If not avoided, damage could be caused to the product or something in its environment.



Important (Refer to manual)

Refers to handling tip and other particularly useful information. This does not signify a dangerous or harmful situation. Refer to manual when this symbol is displayed.

Electrical Safety

The unit has been designed to meet the Essential Health and Safety Requirements of the Machinery Directive 2006/42/EC.

Warning

When working with the pump/motor housing open, Live 230/115 volt mains components are accessible. Ensure that the rules and regulations for work on live components are always observed.

Important

To reduce the risk of fire, electric shock or injury:

1. Always isolate the system from the mains power supply before removing the pump/motor access panel.
2. Use only as described in this manual.
3. Connect the system to a properly grounded outlet.

Dangers to eyes, breathing and skin

Once used, the filters within the DPX3500 system may contain a mixture of particulates, some of which may be sub-micron size. When the used filters are moved it may agitate some of this particulate, which could get into the breathing zone and eyes of the operative. Additionally, depending on the materials being processed, the particulate may be an irritant to the skin.

Caution: When changing used filters always wear a mask, safety shoes, goggles and gloves as a minimum. User must perform a risk assessment prior to any maintenance.

Carbon selection

Please note that the media within the gas filter fitted in the DPX3500 is capable of adsorbing a wide range of organic compounds. However, it is the responsibility of the user to ensure it is suitable for the particular application it is being used on, based on the risk assessment performed by the user.

Intended use

The Domino DPX3500 Laser Extraction System is designed as a non-safety related system to extract particulates, fumes and gases (extraction mixture) generated by a laser process.

The Domino DPX3500 Laser Extraction System is exclusively designed to be used in laser processes that:

- does not create burning or hot particles that do not safely extinguish and cool down before they touch ignitable ablations in the piping or in the filters.
- produces extraction mixtures that would not create a risk to human health in the time taken for the process to be stopped, by other means, after an undetected extraction system fault
- is located in a well-ventilated area.

The extraction base unit must also be placed in a well-ventilated area.

The Domino DPX3500 Laser Extraction System creates a volume regulated and monitored airflow away from the laser process within the coding area of goods. It is intended to keep the area of coding mostly free from accumulating particulates to ensure high quality coding

For a sufficient capturing of particulates, fumes, and gases at the laser process source the system must be adapted to the individual laser process setup. For this the extraction base unit can be combined with different hoses and nozzles or fume extraction shrouds.

Inside the extraction base unit, the fumes are guided through a pre and a main filter, those pre-treat the extracted mixture of particulates and fumes up to a point where they can be safely transported to a final treatment without blocking the pipework. The filter load is monitored, and the system is signalling the laser process to be stopped if the set airflow range cannot be maintained for any reason.

To gain a good extraction mixture pre-treatment and acceptable filter lifetime different filter types are offered and can be used with the extraction base unit.

The extraction base unit keeps the extraction mixture in a closed loop between suction entry and exhaust. This is only opened to the environment for filter exchange.

In normal use the extraction keeps running for some time after the laser process told it to stop - this removes the rest of the extraction mixture from the pipework and the empty space around the filters.

The exhaust is prepared to connect a pipe guiding the pre-treated extraction mixture to its next destination. Only a risk assessment based on the individual laser process composition can decide how to handle the pre-treated extraction mixture.

In many installations this will be a vent to atmosphere point on the outside of the factory. This point must always have a good natural ventilation and be away from other air intakes and people meeting points.

Sometimes the by-products of a laser process and the pre-treatment of the extraction mixture may fit good enough to recirculate the air. To be able to check this the filter performance of the System is known and documented so that it can be used in an individual risk assessment.

Excluded use

The DPX3500 Laser Extraction System excludes the use within a non-professional or domestic environment. The DPX3500 Laser Extraction System is not a Health and Safety product. For example, the extractor will not filter air for human consumption. The extraction mixtures that the system extracts may not create a risk to human health in the time taken for the process to stop, by other means, after an undetected extraction system fault. The Domino DPX3500 Laser Extraction System may not be used in laser processes that create burning particles that do not safely extinguish before they can ignite ablations in the piping or in the filters. The DPX3500 Laser Extraction System excludes the use in a factory environment which already contains high levels of particulates and fumes.

The DPX3500 Laser Extraction System excludes the use as a general-purpose vacuum cleaner.

The DPX3500 Laser Extraction System should not be used on processes where sparks of flammable materials could make their way into the extraction system or with explosive dust and gases, without implementation of additional precautions.

The DPX3500 Laser Extraction System must not be used on wet applications or acidic fumes. For example, ablation by laser of Polyvinyl Chloride (PVC).

Intended circle of users

The DPX3500 Laser Extraction System is intended for professional use only. Only qualified and authorised personnel shall operate the DPX3500 Laser Extraction System. The DPX3500 Laser Extraction System must only be maintained, serviced, and disposed of by authorised and specifically trained personnel who are familiar with the defined procedures. This special training is available via the Domino Laser Academy (it is not a standard laser training).

Domino Technical Service

If a problem arises with your DPX3500 system, or if it displays a fault code, please refer to the alarms guide within section 5.06 of this manual. If the problem is still not resolved, please contact your local Domino distributor or:

- Contact the helpline on:
Tel: +44 (0) 1954 782 551,
Fax: +44 (0) 1954 782 874

Safety Instructions



Warning and Information labels

The following listing details labels used on your DPX3500 unit.

Goggles, Gloves & Mask Label



Meaning: Goggles, Gloves and Masks should be worn while handling used filters and refer to the user manual.

Electrical Danger



Meaning: Removal of panels with this label attached will allow access to potentially live components.

Warning Label



Meaning: Power should be isolated before the panel with this label attached is opened/ removed.

Heavy item Label



Meaning: Best practice manual handling to be used when lifting this item, refer to customer risk assessment.

Manufacturer address



Meaning: The address of which the product was manufactured, the location of this symbol is found on the marking plate.

Fire Risk Warning

In the very rare event that a burning ember or spark is drawn into the fume extraction unit, it may be possible that the particulate within the filters will ignite.

Whilst any resultant fire would typically be retained within the fume extraction unit, the damage to the extractor could be significant. It is therefore essential to minimise the possibility of this occurring by undertaking an appropriate Risk assessment to determine:

- a). Whether additional fire protection equipment should be installed.
- b). Appropriate maintenance procedures to prevent the risk of build-up of debris which could potentially combust.

This unit should not be used on processes where sparks could occur, with explosive dusts and gases, or with particulates which can be pyrophoric (can spontaneously ignite), without implementation of additional precautions.

It is essential that nozzles or other extraction/ fume capture devices and hoses/pipework are cleaned regularly to prevent the build-up of potentially ignitable debris.

Application environment

The DPX3500 Laser Extraction System is intended for a permanent installation within a manufacturing site and in areas similar to manufacturing sites.

The DPX3500 Laser Extraction System must be installed in areas that comply with the following environmental conditions:

- Indoor and is not subjected to weathering conditions.
- The installation room must be equipped with suitable room ventilation to disperse any residual exhaust gases.

Marking plate Label:

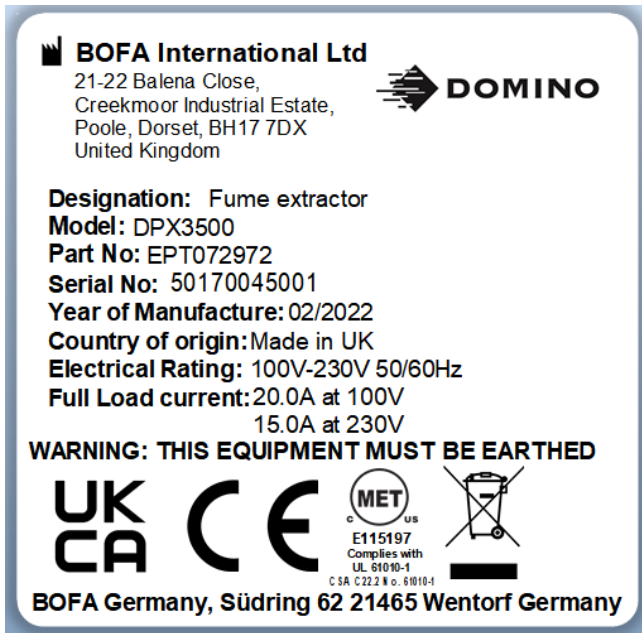

Location: adjacent to the incoming supply.

Meaning: This label contains a variety of information about the extraction unit, including:

- Manufacturer name, Address
- Extractor model
- Part number
- Unit serial number
- Operating voltage range
- Maximum current load
- Operating frequency
- Year of Manufacture
- Relevant approval markings/ logos

PLEASE NOTE: If the equipment is used in a manner not specified by the manufacturer, the protection provided by the equipment may be compromised.

Before installation



Installation and service

Installation and de-installation of the DPX3500 Laser Extraction System must be done by professionals.

Install the unit on a firm and level floor and keep the exhaust outlet clear of obstructions. The rear of the DPX3500 Laser Extraction System must not be closer than 100mm to a vertical wall or surface. Do not install the unit in any outdoor area, or any area that is subjected to weathering conditions. Service of the DPX3500 Laser Extraction System must be completed by professionals.

Inner transit packaging removal & unit placement

Before installation, check the extraction unit for damage. All packaging must be removed before the unit is connected to the power supply.

Please read all instructions in this manual before using this extractor.

1. Move the unit to the location where it is going to be installed and remove the outer packaging. **This unit should be installed in a sufficiently ventilated area.**
2. With the unit in position lock the 2 front castors.

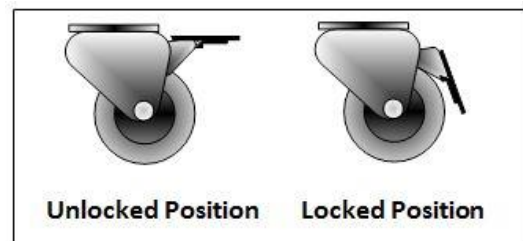

3. Open the front door and insert the main filter onto the shelf and lift into place by rotating the cam handle 180 degrees clockwise.



5. Check the filters are located in their correct position before closing the door and securing the door latches.

Note: The unit will not operate correctly if the Main filter has not been secured in place using the internal lever. (As detailed below)



Caution 

Due to the weight of the extractor suitable lifting equipment should be used and with regard to appropriate safety precautions. (See Appendix for product weight details)

Ensure that 500 mm space is available around any vented panels on the extractor to ensure adequate airflow.

4. Insert the desired Pre-filter from the options provided by Domino; F6, F8 or F9.

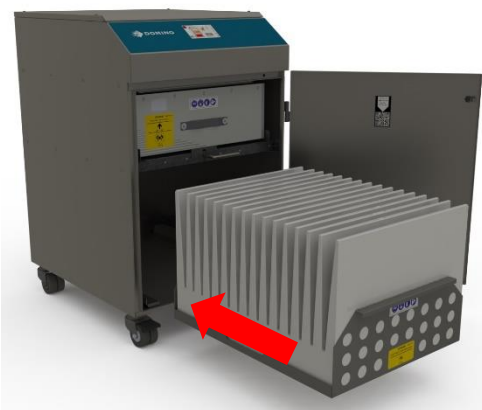

Installation

4₀₁

The DPX3500 has been designed to remove and filter fume containing potentially hazardous particulate and gases generated during manufacturing processes. Such hazardous substances are captured within a multistage filtration system after which the filtered air is returned to the workplace.

Fume Capture Methods

The fume is normally captured by 1 of 3 methods.

- Flexible arm/ Nozzle
- Enclosures
- Cabinets

General Guidelines for a successful installation

- Keep hose run length to a minimum
- Avoid sharp bends / turns in the ductwork
- Avoid multiple bends / turns in the ductwork
- Position the capture device as close as possible to the marking point. (If used on high speed lines, position the capture device slightly downstream).

For all aluminium applications, it is strongly recommended to use flexible hose- or solid pipework, the material of which must withstand at least a maximum operating temperature of 500 °C.

The inner diameter of the flexible hose or solid pipe must not exceed 75 mm to ensure sufficient particle transportation velocity. Smaller diameters will also ensure a sufficient particle transportation velocity but will increase pressure losses and result in reduced filter life.

Make sure that the solid pipe has a wall thickness of at least 1.5 mm. Check whether, due to the environmental conditions on site, corrosion must be taken into account when selecting the pipe material. The flexible metal hose kit that fulfils all requirements is available as a genuine Domino article.

All cleaning processes during maintenance of the extraction system should be performed with a dry cloth.

Surfaces with minor residues in the form of fine particles can be considered cleaned.

When planning a fixed piping system, please consider inspection openings allowing for the cleaning process of the piping according to your own risk assessment.

Installation Guidelines:

- The length of hose runs should be as short as reasonably possible.
- Hoses should be kept as straight as possible with the least number of bends required.
- Any surplus hose should be cut off and not coiled up.
- Hoses should be free from any kinks and should also be free from any obstruction.
- When connecting a hose to a unit where the hose is the same diameter, they should be pushed together as close as possible before tightening the rubber boot coupling (see below):

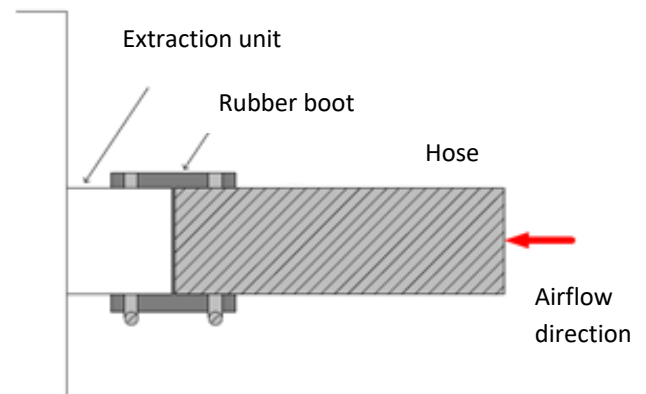

- When connecting a hose with a smaller diameter to a unit, it should sit just inside the inlet spigot before tightening the rubber boot coupling (see below):

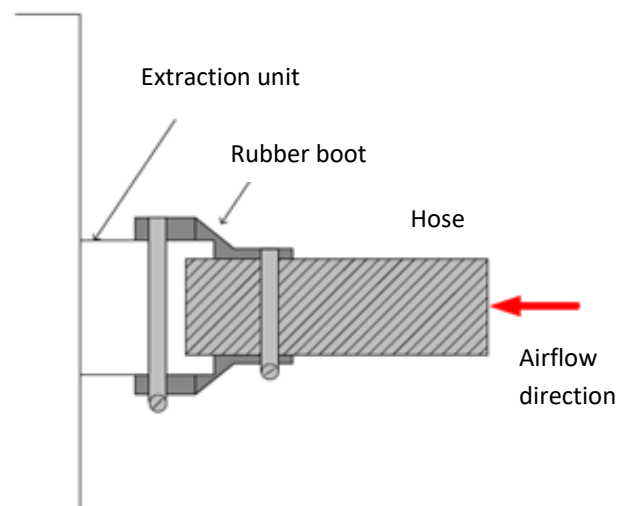

Flexible Arm & Nozzle Extraction

The stay put arm should be mounted as close as possible to the marking point it is recommended to use horseshoe clips. Unscrew the push fit connector from the other side of the flexible hose. Cut the flexible hose to suit the distance back to the extractor connection and push onto the extractor inlet.

Purge air should be kept to a minimum, where possible, to prevent the fume being blown away from the nozzle. High speed production lines may need bigger scoops or nozzles both sides of the bottles because of the turbulence caused by the speed of the bottles.

Moving products

For applications where the product to be marked is moving past the stationary laser head the capture nozzle should be positioned as close as possible to the marking area on the side the product is moving towards.

Enclosures

The extraction hose and nozzle can be attached to the enclosure surrounding the marking zone provided that the extraction point is within 50-75mm of the marking point.

Cabinets

Cabinets normally have a 75mm or 100mm spigot for fume extraction. For best performance use the same diameter hose as the spigot and reduce at the extractor end if necessary. **Keep the hose run as short as possible.**

Type of contaminant (as described by HSG258 table 12)	Indicative duct velocity (as required by HSG258 table 12)	Minimum airflow required for 75mm ² hose kit	Minimum airflow required for 100mm ² hose kit
Gases and non-condensing vapours	5 m/s	200 m ³ /h	200 m ³ /h
Condensing vapours, fume, and smoke	10 m/s	200 m ³ /h	290 m ³ /h
Low or medium density, low moisture content dusts (plastic dust, sawdust), fine dusts and mists	15 m/s	240 m ³ /h	430 m ³ /h

Connection to extraction unit

All ductwork should be installed and connected to the extraction unit before the DPX3500 system is turned on.

Exhausting filtered air outside

Your DPX3500 extraction unit has an option to exhaust through an outlet spigot. This provides a connection point for exhaust pipework to be fitted. It is important to keep any ducting to a minimum, in order to reduce back pressure within the system.

Guidelines for an effective installation

The extraction nozzle shall be installed downstream of the fume source, so as to ensure that the fumes are transported in the direction of the extraction nozzle.

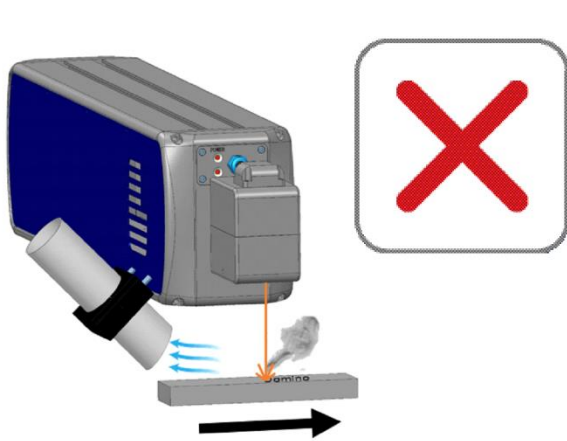

Incorrect nozzle position – fumes drawn along with the product movement away from the nozzle.

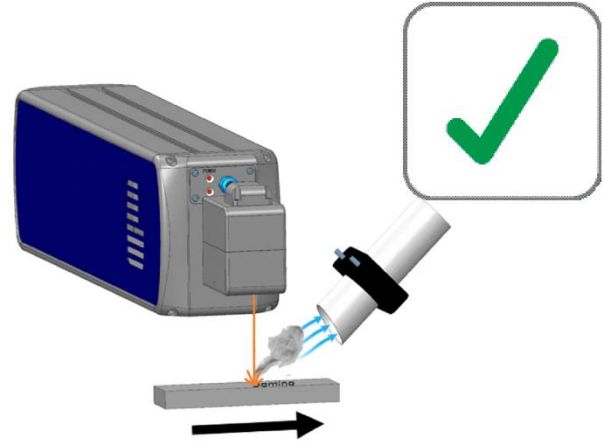

Correct nozzle position – fumes drawn along with the product movement into the nozzle.

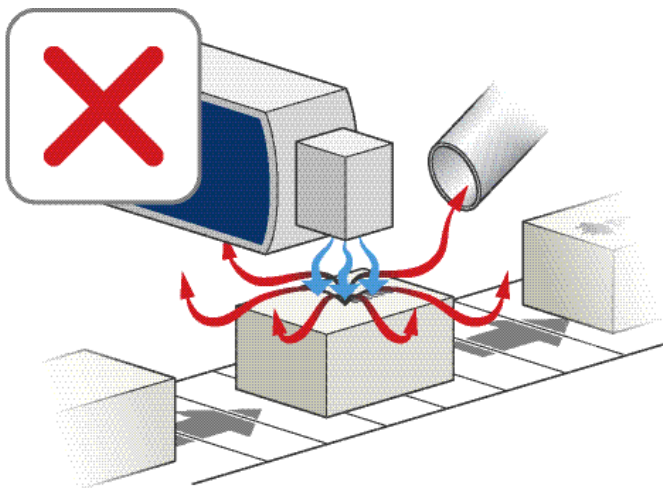

Incorrect lens air – air too strong, and the fumes are being blown away from the extractor hose inlet.

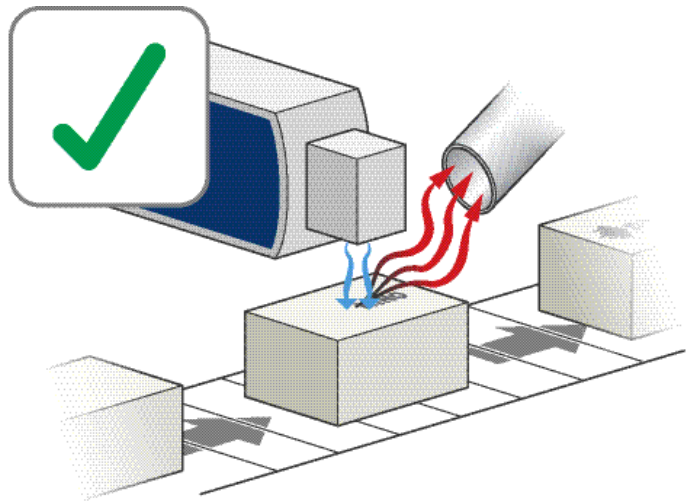

Correct lens air – the fumes are being drawn into the extractor hose inlet.

If the extraction equipment is incorrectly setup and not maintained frequently particle collections can build up, forming lumps of debris. In high production rate applications and/or with some materials these lumps may be hot.

If the debris lumps get large enough, they may break free and enter the extraction unit, and if they are hot enough there is a chance for it to ignite the dust within the pre filter. To prevent this ensure the guidelines for an effective installation are followed and maintenance as per 8.01, within this manual is followed.

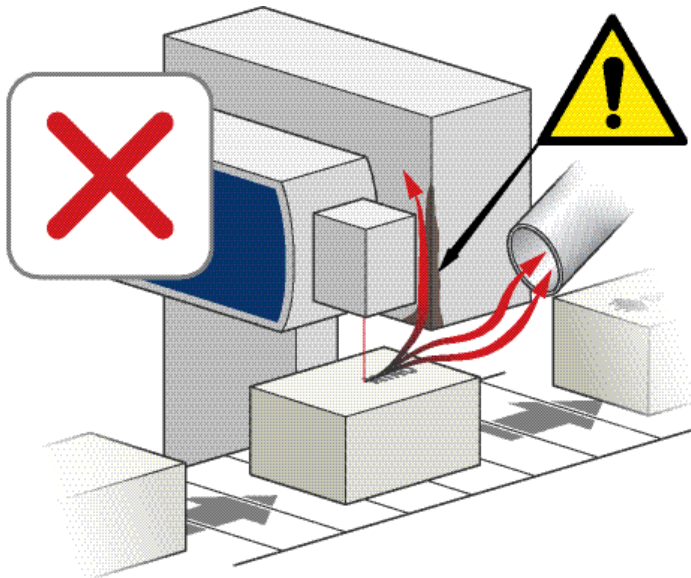

Incorrect – Part of the process equipment is blocking the fume path, which may cause a build up of debris.

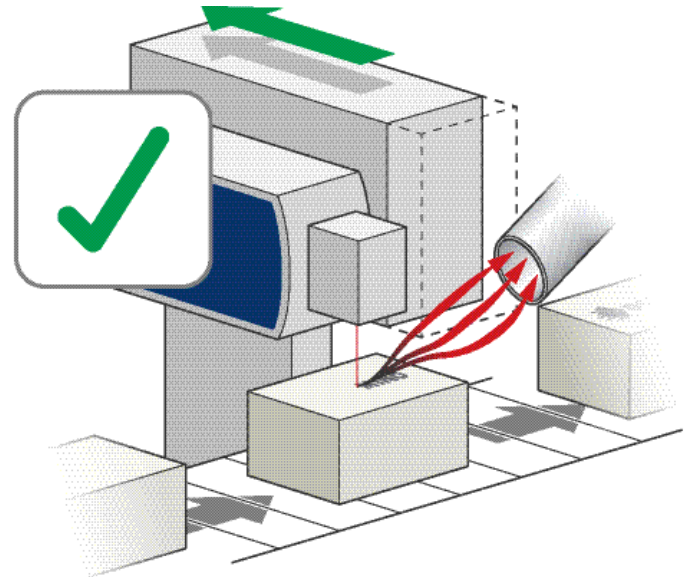

Correct – All parts of the process equipment are out of the fume path, preventing the build up of debris.

Installation

4⁰²

Remote Stop/Start feature

Is a mandatory feature that enables the extraction unit to be remotely turned On / Off via an external signal. The voltage required is detailed below.

- DC Voltage input – 24VDC

Note: Care must be taken to ensure that the system is correctly wired in order for the extraction unit to function correctly.

Extractor controlled by a Domino laser controller:

- Ensure the install option "vacuum" is activated within the laser software (see Domino laser product manual).
- Ensure that the controller software version is 4.2.2.4. or newer.

Extractor controlled by PLC:

- Ensure that the extractor is operating before the laser system is activated.
- Ensure the extractor is operating a certain time (recommended 3 minutes) after the laser has been set into standby.
- Monitor the System OK feedback signal (Pin 1) of the extractor that it behaves as illustrated in the signal-time-diagram below.

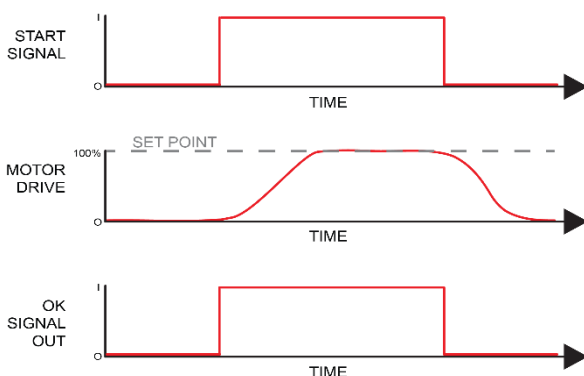

DC Voltage input

This configuration requires Pin 5 (+) and Pin 2 (-) of the connector (Refer to section 1 for location) to be connected to a known and tested DC power supply, of a laser controller or

PLC.

The operating voltage for this signal is between 12 & 24VDC. Only voltages within this range should be connected. Voltages connected outside of this range may cause irreversible damage to the internal control PCB.

When the extractor is provided with the correct DC voltage the motor will start and maintain the set flow rate (Refer to section 5 for how to set the flow) when the DC voltage is removed the motor will slow down and come to a stop.

The extractor will need to be turned on and be out of standby mode (See section 5 for turning the extractor on) in order for this feature to operate.

The power supply unit which is used to provide the 12-24VDC start stop voltage signal must be protected by double insulation from mains voltage.

Filter warning & System Fail Signal

With this option the system will output a signal to alert the user when the extractor has failed or when the filters are blocked.

This feature will not directly stop the extractor from running correctly, but if fitted this feature should be terminated correctly before power is applied to the system.

Connection specification

System OK: Signal given between Pins 1 & 6.

Filters 85% blocked: Signal given between Pins 3 & 4.

The system will provide a volt free Open / Closed signal that can be connected to an external interface, beacon or warning device following the specification below.

- **Maximum input voltage: 24V AC**
- **Maximum current load: 3A @ AC**
- OR**
- **Maximum input voltage: 24V DC**
- **Maximum input load: 3A @ DC**

Pin configuration:

- 1: System OK output N/O
- 2: Start signal input GND
- 3: Filters 85% blocked output N/C
- 4: Filters 85% blocked COM
- 5: Start signal input 24VDC
- 6: System OK output COM

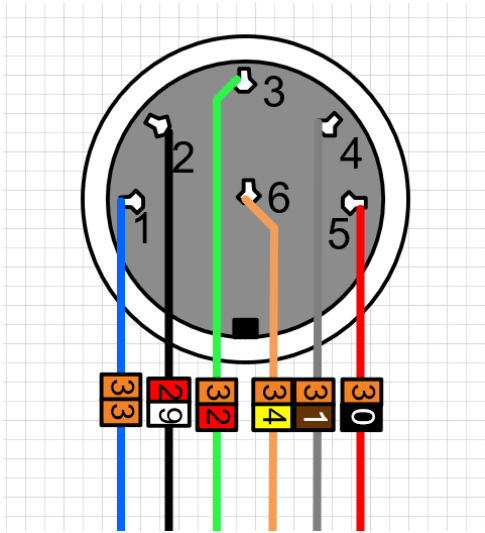

Internal connections of interface connection

Installation

4₀₃



Connection to Power Supply

Please the specification in section 9.01 when selecting the power supply outlet for the DPX3500 system, ensure the power supply is suitable before connecting the DPX3500 system.

Check the Integrity of the electrical power cable. If the supply cord is damaged the extraction unit should not be connected to the mains. The supply cord should only be replaced by a Domino service engineer as an electrical safety test may be required after replacement.

The DPX3500 system **MUST** be connected to a properly earthed outlet.



The DPX3500 system is supplied with mandatory interfacing please read section 4.02 before the power connection is made as additional connections may be required before power is connected to the extractor.

Connect the power cable to an isolated electrical supply.

The mains socket should be installed near the extractor it should be easily accessible and able to be switched On or Off. The cable run should be arranged so as not to create a trip hazard.

Changing the exhaust orientation

The exhaust has two orientations it can be used in “vent to air” and “Exhaust box”. To change from one orientation to another; the four M5 bolts need to be removed and then the following sequence of images are followed:



Operation



Turning extraction unit On

Use the mains switch on the rear of the extractor to power up the unit. (Refer to section 1 for switch location) by pressing the Green side / (I) of the switch. The screen will now illuminate.

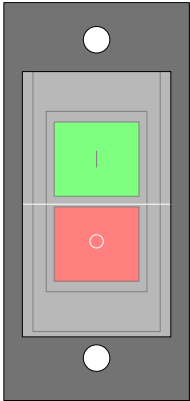

Power on cycle

Once the extraction unit has been turned on the below sequence will appear on the screen.

Off



Loading



Home screen



Operation



Accessing the menu & first time operation

During first time installation the DPX3500 system will automatically take you to the “settings” page to configure initial settings.

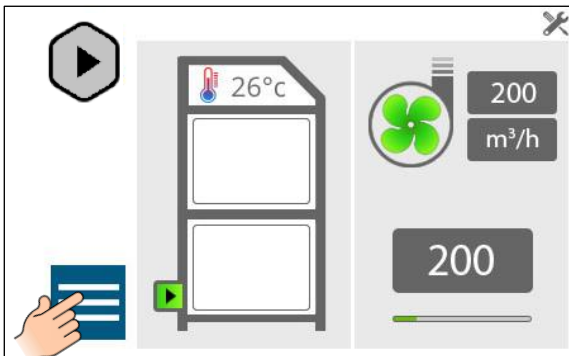

Settings

The settings feature has three programmable parameters:

1. **Display units**
2. **Service mode**
3. **Language**

To access the menu, follow the icons below:

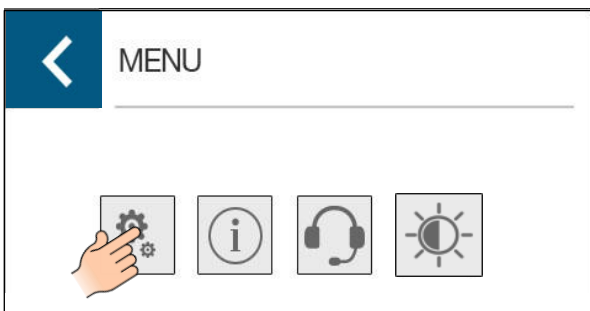

Changing the display units

The Airflow and temperature readings can be displayed in 2 ways.

1. Temperature displayed as °C
Airflow displayed as m³/h on the metric setting (Default)
OR
2. Temperature displayed as °F
Airflow displayed as CFM on the imperial setting

Service mode

Disabling the service mode feature (Default) will allow the extraction unit to be remotely turned On and Off via an external signal. The enabled setting shall only be used by Domino trained service technicians for maintenance. This feature is configured as below:

- DC Voltage input – Range 12-24VDC

Note: Care must be taken to ensure that the system is correctly wired in order for the extraction unit to function correctly.

DC Voltage input

This configuration requires the Black & Red cores of the signal cable (Refer to section 1 for location) to be connected to a known and tested DC power supply, in order to start the extractor.

The operating voltage for this signal is between 12 & 24VDC. Only voltages within this range should be connected. Voltages connected outside of this range may cause irreversible damage to the internal control PCB.

Red cable = V+
Black cable = V-

When the extractor is provided with the correct DC voltage the motor will start and maintain the set flow rate (Refer to section 5.4 for how to set the flow) when the DC voltage is removed the motor will slow down and come to a stop.

The extractor will need to be turned on and be out of standby mode (See section 5.1 for turning the extractor on) in order for this feature to operate.

Volt free input

This configuration requires the Black & Red cores of the signal cable (see section 1 for location) to be connected together, in order to start the extractor. When the 2 cables are connected together the motor will start and maintain the set flow rate (see section 5.4 for how to set the flow) when the 2 cables are disconnected the motor will slow down and come to a stop. The extractor will need to be turned on and be out of standby mode (See section 5.1 for turning the extractor on) in order for this feature to operate.

Changing the language

The system has five programmable languages :

- English (Default)
- Spanish
- French
- German
- Portuguese

Once the language has been selected it will automatically change the system, no restarts are necessary.

Information

The 'Information Page' will display system information.

- iQ2 PCB serial number
- Software versions
- Logging information

To access the information, see the following icons:

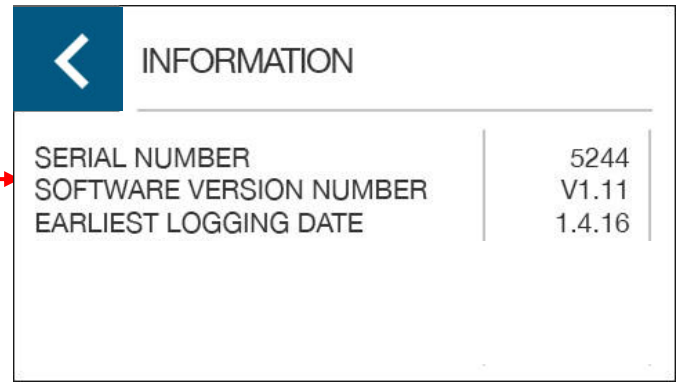
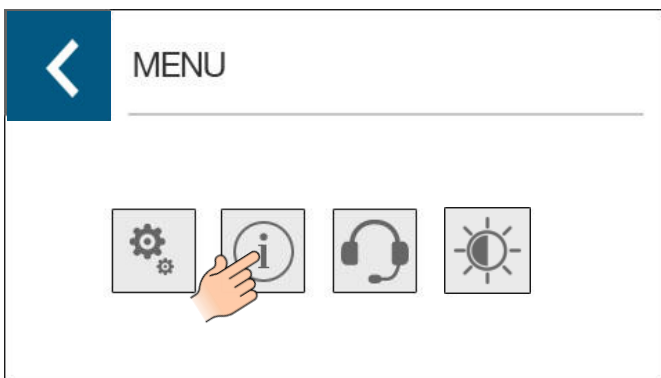

Support

The 'Support' page will display contact information for technical and sales support, to access the support page see the following icons:

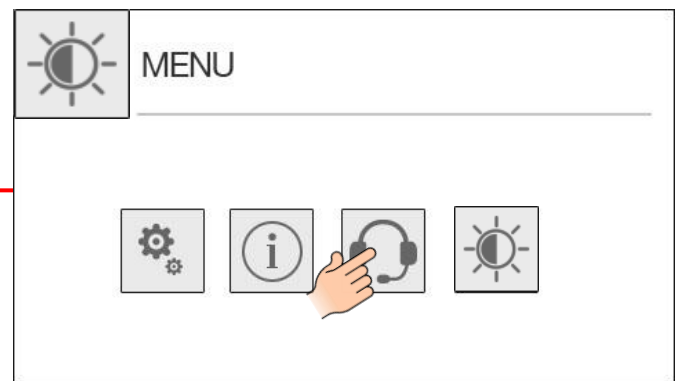

OR

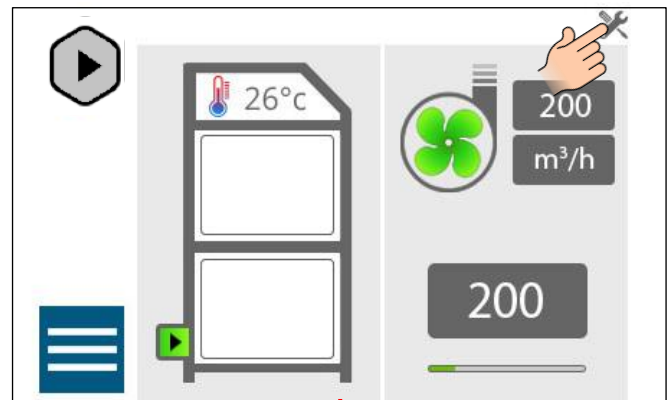

Brightness

Selecting the brightness icon will allow the user to configure the brightness of the DPX3500 display.

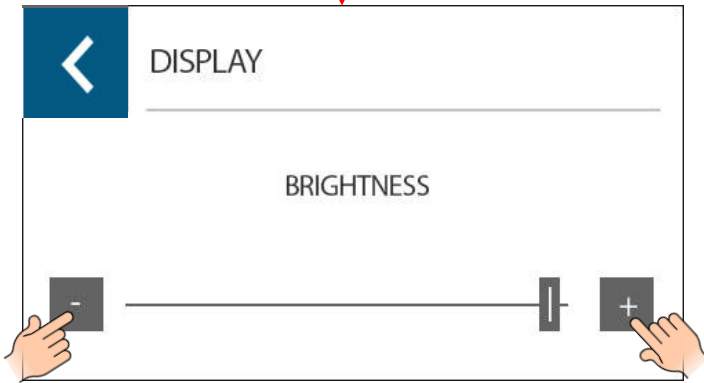
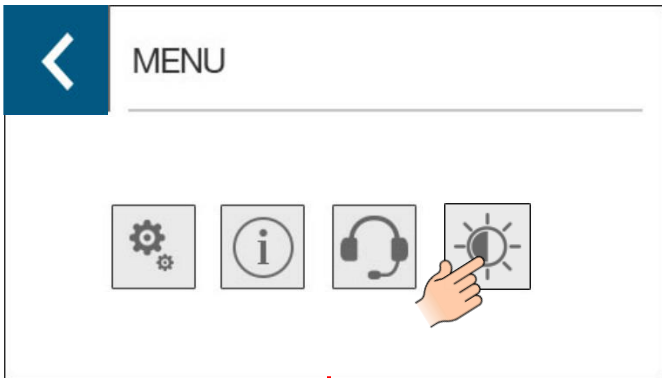

The brightness can be adjusted by pressing either the plus to increase brightness on the display or the minus to decrease brightness on the display.

Note - The DPX3500 system will revert back to the home screen after 7 seconds of inactivity, from any on screen function.

Functional test

During first time operation it is recommended to complete a functional test, to ensure the safety elements of the fume extractor prevent the laser machinery from operating if a fault has occurred or there has been an issue with the initial set up.

To simulate a fault the cam handle for the main filter should be rotated 180 degrees anti-clockwise, which will lower the main filter, which in turn will activate the main filter missing alarm for icons see section 5.06.

The Main filter missing alarm will change the system ok signal (feedback from extractor to the laser controller) which in turn will prevent the laser system from operating, an alarm message should be represented on the laser software.



Operation



Run controls

The extraction unit has the ability to be manually operated by the 'Run Control' but this is only recommended to be used during service by Domino trained service personal.

The 'Run Control' touch button will enter the system into 1 of 2 states:

1. OFF: Unit idle
2. RUNNING: Pumps active

The 'Run Control' button will change its appearance according to its usage based on the systems operation mode.

1. OFF state

In the 'OFF' state the pumps are inactive and the 'Run Control' button will act as a 'START' button. The USB 'Upload/Download' function is available (Disabled in all other states i.e. the motor not running).

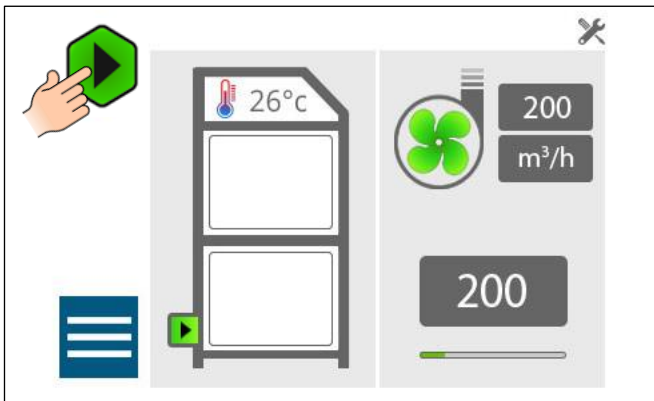

- Note: If the extractor has the service mode setting enabled the "run control" button will be greyed out and the motor will be controlled via the interface cable. The extractor can only be turned off manually by pressing the On/Off switch or the laser stop providing a signal.

2. Running state

When "Running" the pumps will be activated and the "run control" acts as a "stop" button.

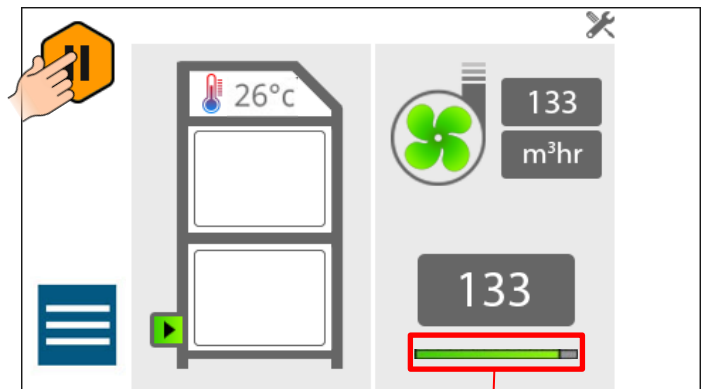

Setpoint Level' indicator

The 'Setpoint Level Indication' gives a visual indication of target setpoint level relative to maximum achievable level. Pressing the indicator will navigate to the 'Airflow Setting' page.

Operation



Setting the desired airflow

The DPX3500 system features automatic flow control. This enables the user to set the required airflow rate, then over time as the filters begin to block the motor will automatically begin to increase in speed to compensate for any loss in performance caused by the added restriction of the partially blocked filters.



The extractor, all pipe work and interfacing must be fully installed and connected before the airflow is set.

To set the airflow

(The airflow can be set between 200-450m³/h)

1. Press the airflow set point button (Refer to diagram below for button location).

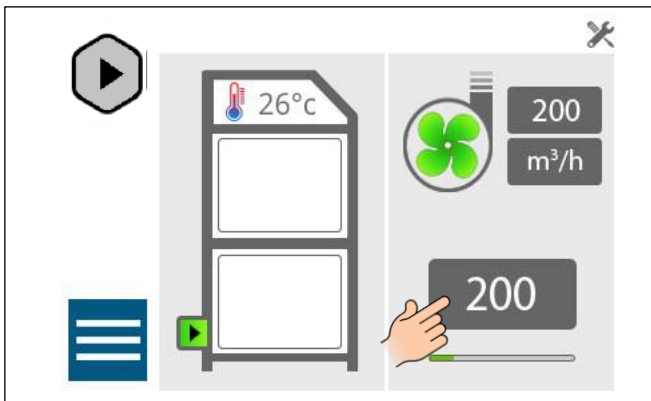

2. The page will have a numeric keypad. The numbers will be enabled depending on the flow limits of the system. DPX3500 has flow limits 200-450. Upon entry only numbers 2-4 will be enabled initially, the system enters the airflow setpoint from left to right, only allowing reachable setpoints and prevents invalid setpoints.



3. Once you have your desired airflow, Press the enter button. Once you have entered a valid airflow the 'Enter' button will be enabled. Pressing 'Enter' will save the entered setpoint and return the display to the main page.

The set airflow will now be maintained throughout the life of the filters. When the extraction unit can no longer maintain the set airflow an alarm will be given and the display will indicate which filter should be changed.

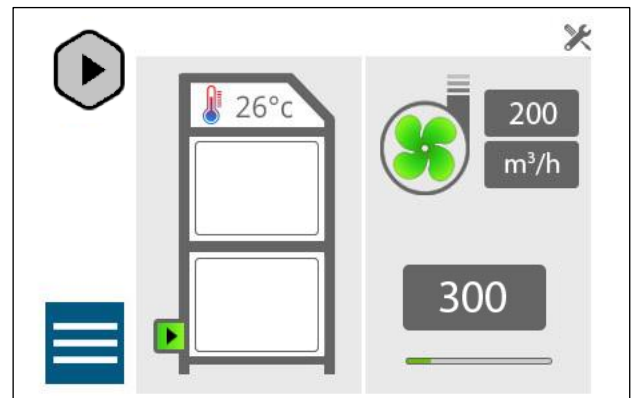

Operation



Filter blockage level indication

The filter icons will fill relative to their blocked value. The filter icons colour will represent their health, refer to section 6-02 for replacement procedure:

1. GREEN: less than 85% blocked



2. AMBER: greater than 85% blocked



3. RED: fully blocked



Filter not installed correctly warning

The 'Filter Status' icon will be replaced by a warning triangle icon to indicate that a missing filter has been detected:

**note this machine only has a sensor for the main filter.*



Inlet Status

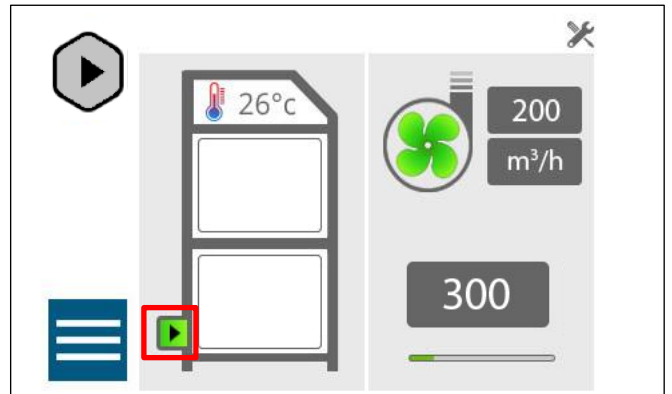

The Inlet icon will give visual feedback to the state of the Inlet duct:

- GREEN: Ok



- AMBER: Warning: High vacuum on pipework



- RED: Fault: Blockage



If the amber warning or red fault light appear inspect the hose kit and installation (refer to section 8.01 for maintenance instructions). And reduce the restriction causing the high vacuum or blockage.

When the above "inlet status" icon is pressed the system information page as seen below is displayed.

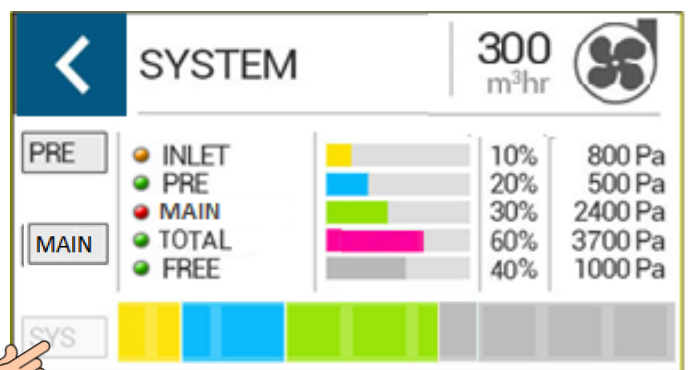

The differential pressure across each section of the system will be displayed. A 'System Overview' bar graph will be displayed to easily visualise the pressures across the system.

- Airflow: Current airflow reading
- Inlet Pressure
- Pre-Filter Pressure
- Main Filter Pressure
- Total system pressure
- Free: Available head pressure for system at current airflow

Each section will have a traffic light warning icon indicating the health of the section.

The page will display the systems current flow. This page as well as the pre and main filter pages will have a pump icon displaying the pumps state, pressing will navigate the user to the 'Pump Diagnostics' this page is also accessible from the home screen, as seen below:

Each connected pump will be accessible from this page. They can be selected by pressing the corresponding number at the top of the page. The pump selection bar will populate with the amount of pumps Each connected pump will be accessible from this page. The pump selection bar will populate with the amount of pumps connected to the system. The page will display the following pump data:

- Speed: RPM
- Head Pressure: Pa
- Drive: Voltage or PWM (Pump Dependant)
- Beneath Drive voltage a percentage figure of how much of the drive voltage is being used is shown.

The pump selection icons will display RED if an error has been detected with the associated pump.

The 'Back' button will navigate back to the previous screen.

Filter Status

The 'main and Pre-Filter' pages will hold all the data relevant to the combined filters state.

- Filter block level relative to achievable system pressure (%)
- Pressure: Differential pressure across filter (Pa)

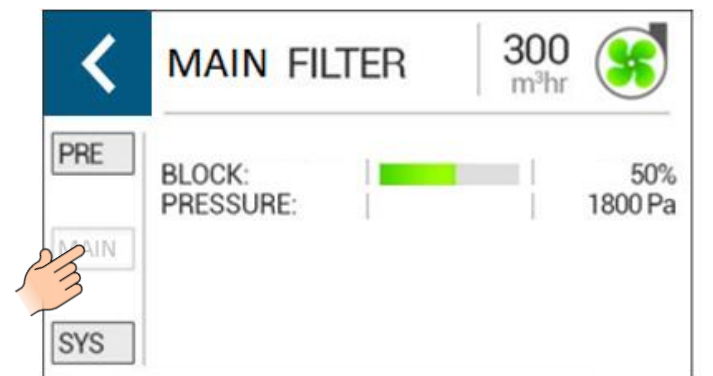
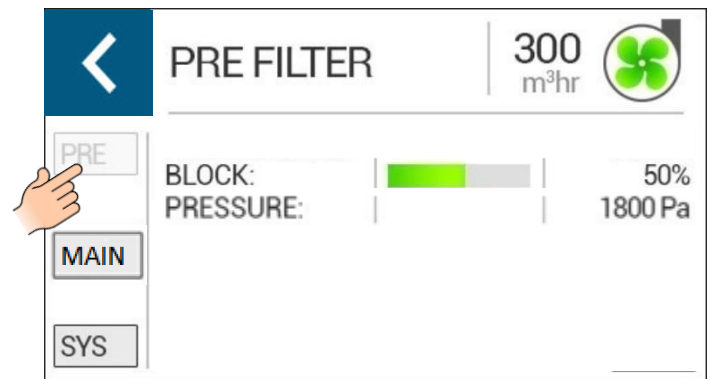
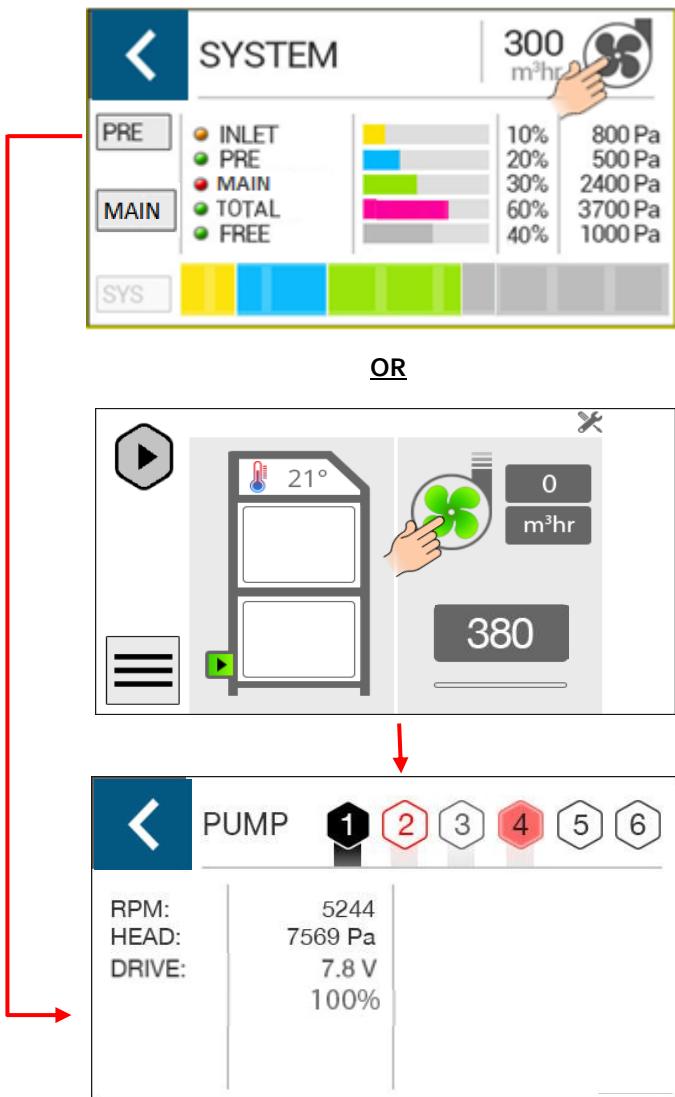

System temperature

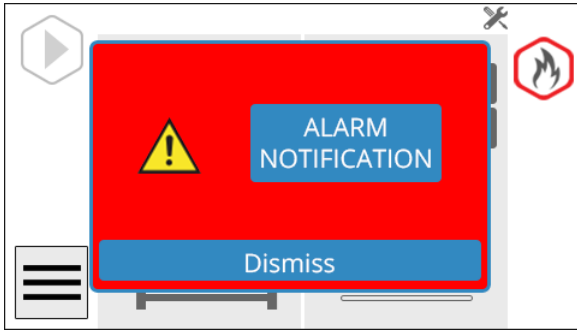

The system has an internally mounted thermal trip. That detects the temperature in the filter compartment. If the temperature rises above 55°C then the extraction unit will automatically shut down the motor and display the symbol above.

If this symbol is displayed the unit should be totally isolated from the mains supply and the unit should be fully inspected by a Domino trained technician for evidence of the temperature rise. (Including inside the Pre-filter).

Once the unit is safe to turn back on and the internal temperature has dropped below 50°C (122°F) the thermal trip can be reset. To do this follow the procedure below.

1. Isolate the supply from the extractor
2. Open the front door & remove the main filter
3. Locate the circular cut out in the shelf, at the front of the unit.
4. Inside the cut out there is a small red button that can now be pressed back in.
5. Re-fit the main filter, close the front door and re connect the mains supply.

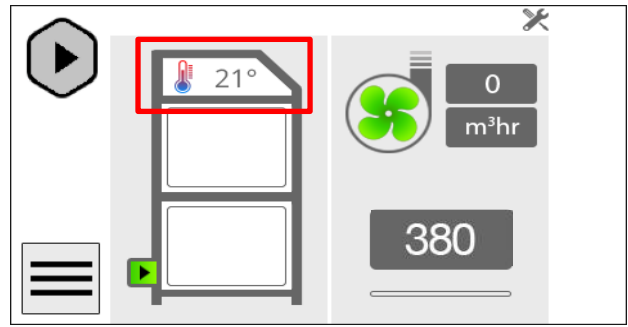
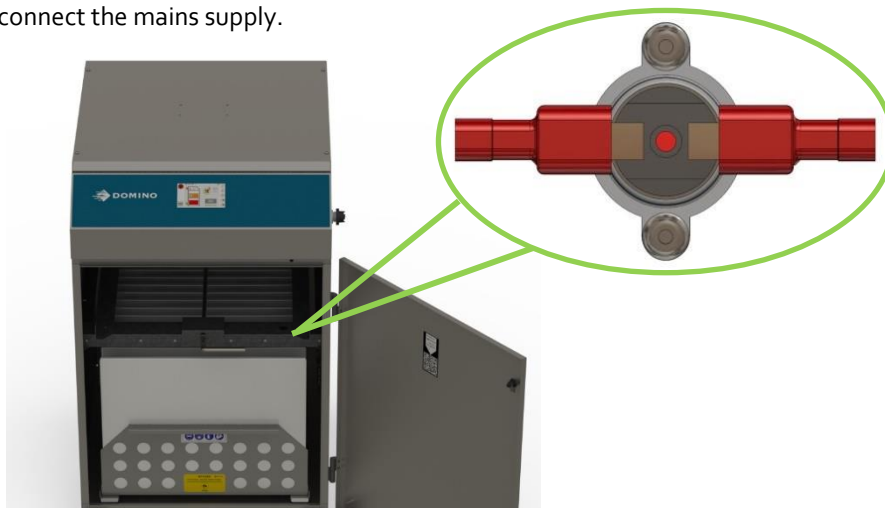

The units' internal temperature will be displayed on the screen. The temperature reading will follow the traffic light format:

- Temperature: less than 40°C (104°F) (GREY)



- Temperature: greater than 60°C (140°F) (RED)



If the temperature exceeds the alarm threshold the numeric reading will turn red and flash to draw attention to the user, if this temperature reaches 60 °c the pump will shutdown and will not restart until it the temperature is below 60 °c and the unit has been reset.

Operation



Alarms

The 'Alarm Notification' bar will populate with active alarms as they occur. The alarm icons will populate from bottom to top. The alarms will disappear once resolved. The bar will be able to display 5 active alarms at a time. If more alarms are active the alarm icons will be spread across two or more pages that will show alternately at continuous intervals of 5 seconds.

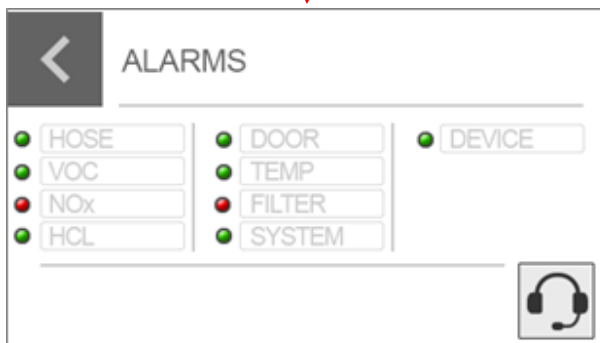
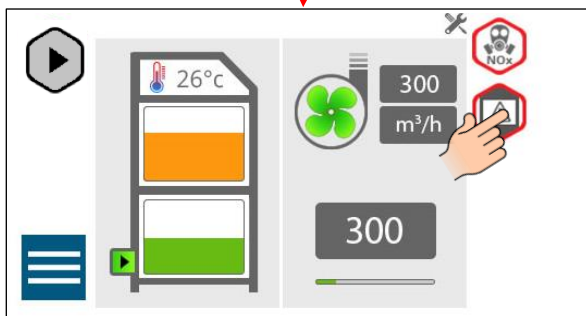
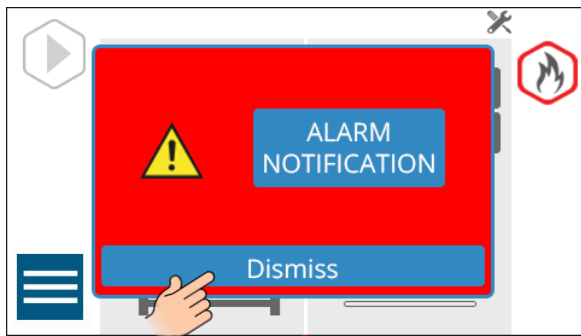

The alarms that the machine will indicate are:

- VOC
- Thermal
- Hose blocked
- Main filter not fitted correctly
- iQ2 board overheating
- Device
- System fault

Filter signal

- 1) Low: Pre and/or main filter is filled by 85% or more particulate.
- 2) High: Pre and/or main filter is filled by 84% or less particulate.

OK signal

- 3) High: Extractor is operating
- 4) Low: Extractor stops operation

VOC



Filter signal: High

OK signal: High

The VOC (Volatile Organic Compound) sensing will be constantly monitoring the exhaust gas of the extraction unit.

If the VOC level in the exhaust exceeds the PPM (Parts per million) Pre-set level then the Gas alarm will be triggered and display the Gas icon as shown above.

Removing the VOC alarm warning

The VOC option is a perfect way to monitor how the carbon section of the main filter is performing. Once the activated carbon within the filter is saturated the VOC sensor will alarm. At this point the extractor should be isolated from the mains and a new main filter fitted. Once a new filter is installed the alarm will clear.

Thermal



Filter signal: High

OK signal: Low

If the DPX3500 system detects an internal temperature greater than 55°C then it will automatically shut down the extractor to prevent damage to components within the extractor, and the above symbol will appear. Once the internal temperature has dropped by 5°C the extraction unit will be able to restart. To restart the extractor after an over temperature alarm the unit reset button on the thermal trip needs to be pressed (refer to section 5.05).

Hose blocked



Filter signal: Low

OK signal: Low

This alarm will become active when the DPX3500 system detects a full blockage in the installation. The DPX3500 system interprets a full blockage as a vacuum spike within the ductwork and is considered a full blocked as the extractor cannot maintain the set airflow with the blockage present.

During this time it is normal to hear the motor increase in speed. The blockage will need to remain in the ductwork for over 5 seconds before the alarm is given.

To remove the blockage, isolate the extraction unit from the mains, remove the flexible hose, locate and remove the blockage then reattach the hose as previously installed.

Main filter not fitted correctly



Filter signal: High

OK signal: Low

If the main filter has not been inserted correctly the symbol above will be displayed. Once the main filter has been inserted correctly the alarm will disappear. For main filter replacement see section 6.02.

iQ2 board overheating



Filter signal: High

OK signal: Low

The iQ2 board is fitted with thermal protection to prevent any of the components being damaged at high temperatures. This is set to 60°C. Once the internal temperature has dropped below 60°C the extraction unit will be able to restart.

Device



Filter signal: High

OK signal: High

If there is VOC board failure, call your local Domino service technician.

System fault



The system fault alarm will be shown if there is a fault with any of the following alarms:

- Pre-filter full
- Main filter full
- Auto adjust

Auto adjust

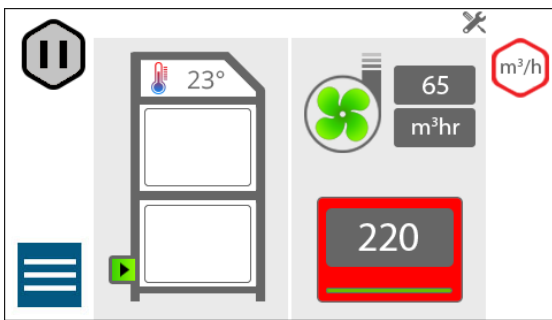

Filter signal: Low then High

OK signal: High

When first setting the airflow on your new extraction unit the iQ2 will detect if the desired airflow is achievable with the installation that has been connected to the extraction unit, if the installation is causing too much restriction for the desired airflow to be reached, the Auto Adjust feature will be activated. The procedure events are listed below.

- 1) The airflow box will begin flashing Red.
- 2) The airflow setting on the screen will drop to display the highest airflow that can be achieved.
- 3) The airflow will stabilise and red box and system fault icon will disappear.

After the auto adjust has been carried out the hose kit should be investigated, the normal cause of auto adjust is too much restriction on the hoses attached to the system.

Pre-filter full

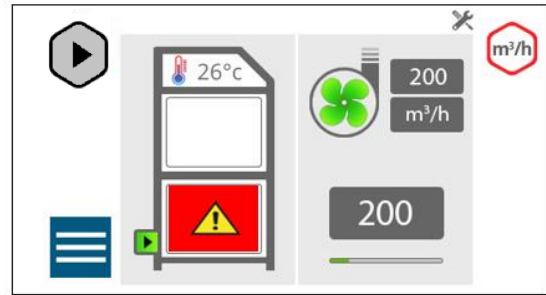

Filter signal: Low

OK signal: Low

When the Pre-filter becomes full, the alarm can only be reset by replacing the Pre-filter to clear the blockage detected by the internal sensors.

Main filter full

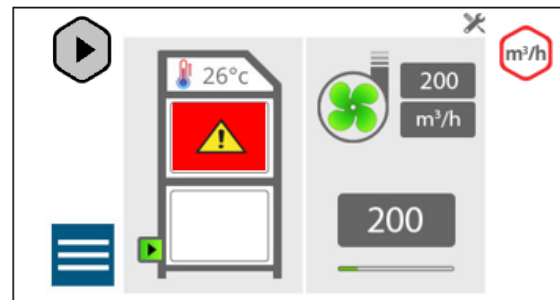

Filter signal: Low

OK signal: Low

When the Main filter becomes full, the alarm can only be reset by replacing the Main filter to clear the blockage detected by the internal sensors.

Maintenance

6₀₁

Maintenance General

Periodic general maintenance must frequently be carried out on the extraction system, when carrying out maintenance ensure isolation from all energy sources. Periodic general maintenance includes as a minimum to dust down all exterior air vents to not limit cooling and extraction. Functionality tests should also be carried out to ensure all controls and systems are operating as they should be.

User maintenance is limited to cleaning the unit and filter replacement, only trained maintenance technicians are authorised to carry out component testing and replacement. Unauthorised work or the use of unauthorised replacement filters may result in a potentially dangerous situation and/or damage to the extractor unit and will invalidate the manufacturer's warranty.

Cleaning the unit

The stainless steel units should be cleaned with a proprietary stainless steel cleaner, in accordance with the manufacturer's user instructions.

Replacing Filters

The DPX3500 system constantly monitors the condition of the individual particle filters. As the filters block the DPX3500 display will show the relevant filter symbol filling up. (see section 5-05 for screen details). If a filter warning appears the filter is recommended to be replaced latest during the next planned maintenance in order to prevent additional downtime.

A log of the changes should be maintained by the user. The filters require attention when the display shows the filter output signal is high, this signals 85% blockage across the two filters.

It is recommended that a spare set of filters are kept on site to avoid prolonged unit unavailability (note, main filters should only be used for 2 years after manufacture date listed on the filter for maximum efficiency). Part numbers

for replacement filters can be found on the filters fitted in your system.

To prevent overheating, units should not be run with a blocked filter condition, or with dust obstruction of Inlets / Outlets.

Pressure sensor maintenance

It is recommended when changing the pre-filter (refer to section 6.02 for pre-filter location and removal) the pressure sensing tube should be cleaned to maintain system accuracy. This section details how to clean the pressure sensing tube, however customer risk assessments should be followed regarding PPE and access to the sensor.

To clean the pressure sensing tube:

1. Disconnect the silicone hose from the top of the sensor tube.
2. Use a pipe cleaner to clear all debris from the stainless-steel tube. (Compressed air may also be used to clean the stainless-steel tube, ensure that the silicone hose has been disconnected as this will damage the pressure sensor).
3. Connect the silicone hose back to the top of the stainless steel sensor tube.



Maintenance

6₀₂

Pre-Filter Replacement

Refer to section 2 02 for PPE requirements.

To remove and replace the Pre-filter follow the procedure detailed below. (Follow the replacement guide that is with each consumable).

1. Isolate the electrical supply to the extractor
2. Undo the latches on the front of the unit and open the door.
3. The Pre-filter is the lower of the 2 filters (refer to section 1 for filter location) using the handle on the front of the filter cage, pull it out of the unit, towards the user.
4. Once removed it is recommended that the used filters are bagged and sealed.
5. Slide the new filter into position making sure it is pushed all the way in and is located correctly on the spigot in the back of the unit.
6. Close the door and fasten the 2 latches.
7. Reconnect the power supply

Main Filter Replacement

To remove and replace the Main filter follow the procedure detailed below.

1. Isolate the electrical supply to the extractor
2. Undo the latches on the front of the unit and open the door.
3. The main filter is the higher of the 2 filters (refer to section 1 for filter location) rotate the lever below the filter through 180° anticlockwise to lower the main filter.
4. Using the handle on the front of the filter, pull it out of the unit being careful to support it as it comes free as it is heavy (Max weight 34Kg, 2-person lift required using side handles).
5. Once removed it is recommended that the used filters are disposed in the box of the new replacement.
6. Slide the new filter into position making sure it is pushed in all the way.
7. Rotate the lever back through 180° clockwise to raise the filter into position.
8. Close the door and fasten the 2 latches
9. Reconnect the power supply

Both filters **MUST** be fitted when the extractor is in use, if the main filter is not installed correctly the DPX3500 system will not allow the motor to operate.



Recommended maintenance

Activity	Interval		
	Daily	Weekly	Monthly
Extraction nozzle – Removal of debris build-ups onto the nozzle or within the extraction area.	✓		
Extraction nozzle and hose – Check correct installation condition and that all fumes are being drawn into the nozzle.	✓		
Check and clean lens – Check correct positioning of extraction nozzle to ensure it has not been moved dangerously close to the position of the laser marking area.	✓		
Extraction unit display status – check the display status of the control panel.		✓	
Extraction unit setup – Check extraction unit setup to see if required airflow.		✓	
Filters – Check if the filters are showing signs of blockage or saturation.		✓	
Extraction nozzle and hose – Check hose and nozzle to ensure there is no blockage.		✓	
Exhaust of the extraction unit – check the exhaust of the extraction unit to determine if any odours are passing through the filter system undetected.			✓
Exhaust of the extraction unit – Check the exhaust from the extraction unit to see if there is any sign of dust carry over.			✓
Main filter – Change main filter.	Minimum – 12 monthly		

Notes on cleaning:

All cleaning processes during maintenance of the extraction system should be performed with a dry cloth.

Minor residues in the form of fine particles on the surfaces can be considered cleaned.

System Display



USB Connectivity

For both download and upload connectivity the machine must be on before inserting USB drive (USB max size 16Gb with no other files on the drive and formatted to FAT32). Once turned on The DPX3500 will allow data to be uploaded or downloaded to/from the system providing the machine is not running:

- Upload
 - Configuration files (Supplied by Domino)
 - Software updates (Supplied by Domino)
- Download
 - System data file

The DPX3500 will allow the user to choose between uploading or downloading data. If no upload data is detected to install the DPX3500 will only allow the user to download:

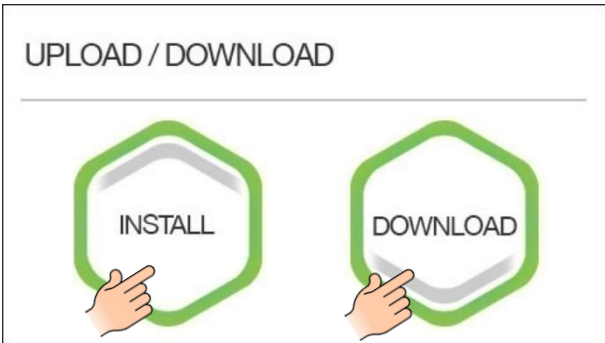

Both options available

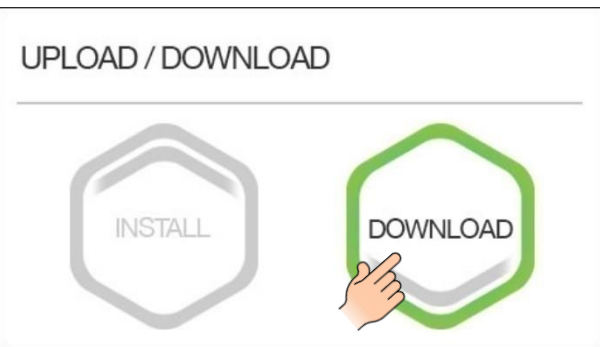

Data detected – download available

If the user selects 'Install' in the 'Upload/Download' selection screen they will be navigated to the 'Upload Selection' screen. There will be two types of upload available:

- Configuration Data: Configuration parameters for unit
- Software: Software update file

The DPX3500 will read the data on the attached memory stick and enable the file choice icon if corresponding file discovered:

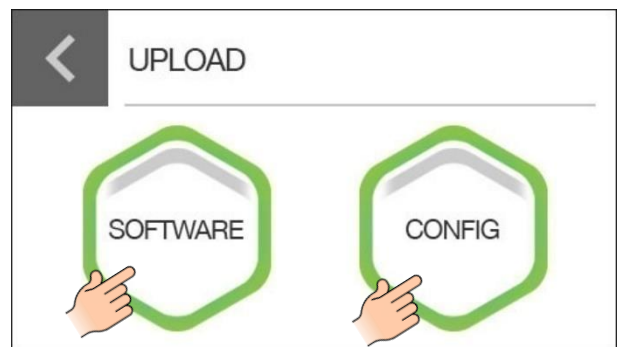

'Upload' Screen – Software and Config file detected

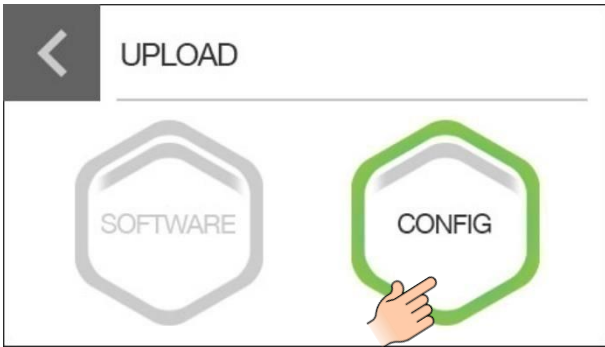

'Upload' Screen - Only Config file detected



'Upload' Screen - Only Software file detected

Once the user has selected their required action the DPX3500 will ask them to confirm:

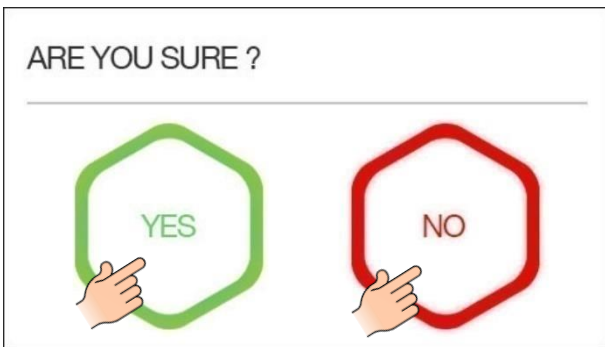

- NO: Will navigate the user to the previous screen
- YES: Will commence with selected action

Once the action has been confirmed the DPX3500 will commence. The progress of the data transaction will be displayed on the screen. A progress bar and numeric reading will give the user feedback of the state of the transaction:

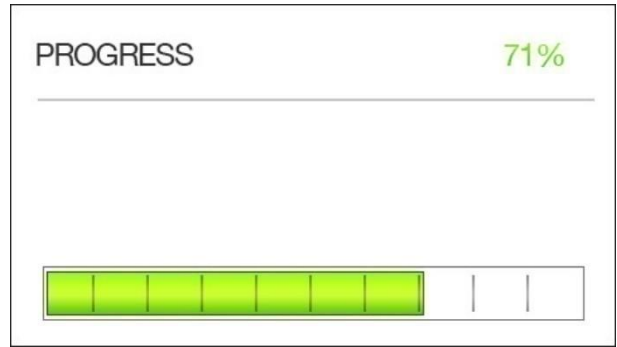

'Progress' Screen - Transaction in progress

(In the event of a "power off" scenario the process is required to be repeated.)

Upon a successful transaction the display will display a 'Tick':

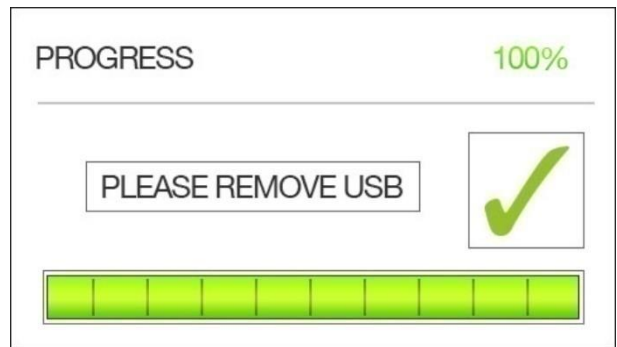

'Progress' Screen - Transaction successfully completed

Once the action has been completed the DPX3500 is required to restart.

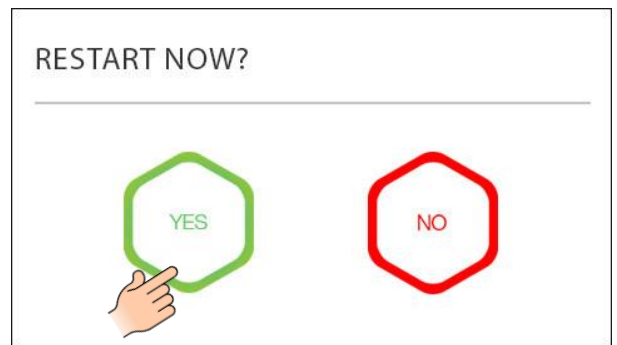

Maintenance protocol



Consumable Spares

The DPX3500 extraction system contains a pre-filter and a main filter. These should be replaced when instructed to do so by the DPX3500 system (see section 6 for replacing the filters)

To maintain performance it is important that the filters are replaced with identical Domino filters. To re-order please refer to the Domino part number printed on the filter installed in your extraction unit.

Maintenance Protocol

The DPX3500 data logging function enables the retrieval of filter change intervals. Users may also wish to record changes on the table below.

Unit Serial Number:			
Pre-filter		Main filter	
Date	Engineer	Date	Engineer

Filter disposal

The Pre and Main filters are manufactured from non-toxic materials. Filters are not re-usable, cleaning used filters is not recommended. The method of disposal of the used filters depends on the material deposited on them.

For your guidance

Deposit	EWC Listing*	Comment
Non Hazardous	15 02 03	Can be disposed of as non-hazardous waste.
Hazardous	15 02 02M	The type of hazard needs to be identified and the associated risks defined. The thresholds for these risks can then be compared with the amount of material in the filters to see if they fall into the hazardous category, if so, the filters will need to be disposed of in line with the local/national regulations.

*European Waste Catalogue

System Specifications



Unit: DPX3500 (Indoor use only)
 Housing material: Stainless Steel
 IP rating: IP56
 Capacity: 450m³/h (265cfm)
 Weight (Including filters): 172kg (379lbs)
 Weight (without filters): 112kg (247lbs)
 Motor: Centrifugal Fan
 Output: 2200w
 Electrical supply: 100-230V (+/-10%)
 Hertz: 47-63Hz
 Full Load Current: 20.0A
 External fuses at mains power supply: Fast blow B/C type
 Recommended rating for fuses:
 110V – 25A
 230V – 20A
 No of phases: 1
 Noise Level: Below 70dB (A)
 (at typical operating speed)

Size:

	Metric (mm)	Imperial (inches)
Height	980	39
Depth	831	33
Width	630	25

Filters:

Filter Type	Surface area	Efficiency
F6 Pre-filter bag	5.0m ²	ISO ePM10 60%
F8 Pre filter	30.0m ²	ISO ePM10 75%
F9 Pre filter	30.0m ²	ISO ePM10 90%
Main filter	3.0m ²	99.997% @ 0.3micron

Main Filter (Gas section)

Filter Type	Carbon type	Amount
Main filter (Gas)	Activated carbon	34kgs

Environmental operating range:

Temperature: +5°C to +45°C
 Temperature range for transport: +5°C to +70°C
 Humidity: Max 80% RH up to 31°C
 Max 50% RH at 40°C
 Pollution degree: 2
 Supply voltage fluctuations: ±10 %
 Maximum altitude for operation: <2000 m
 Factory air changes per hour: minimum 6

Wiring schematic available upon request
Spares parts list available upon request

Contact Information

For sales and service assistance please contact your local Domino Distributer or;

Domino UK

Bar Hill,
Cambridge CB23 8TU,
United Kingdom.

Tel: +44 (0) 1954 782 551

Fax: +44 (0) 1954 782 874

For assistance provided by the manufacturer please contact:

BOFA UK

19-20 Balena Close,
Creekmoor industrial Estate,
Poole,
Dorset BH17 7DU,
United Kingdom.

Tel. +44 (0) 1202 699 444

Email. sales@bofa.co.uk



Domino DPX3500 Product Manual

Domino Printing Sciences plc has a policy of continuous product improvement, the Company therefore reserves the right to modify the specification contained within this document without notice.

© Domino Printing Sciences plc 2022. All rights reserved.



For additional documentation, including other available languages, either scan the QR code, or go to <https://mydomino.domino-printing.com>

Domino UK Limited
Trafalgar Way
Bar Hill
Cambridge CB23 8TU
United Kingdom
Tel: +44 (0)1954 782551
Fax: +44 (0)1954 782874
Email: enquiries@domino-uk.com

Domino Amjet Inc.
1290 Lakeside Drive
Gurnee IL.60031
U.S.A.
Tel: +1 847 244 2501
Fax: +1 847 244 1421
Email: solutions@domino-na.com



EPT076596_1